

PARAFUSO AUTOARRAXANTE AÇO/INOX

TORNILLO ATERRAJADOR RANURADO ACERO/INOXIDABLE
TAPPING SCREW/STAINLESS STEEL

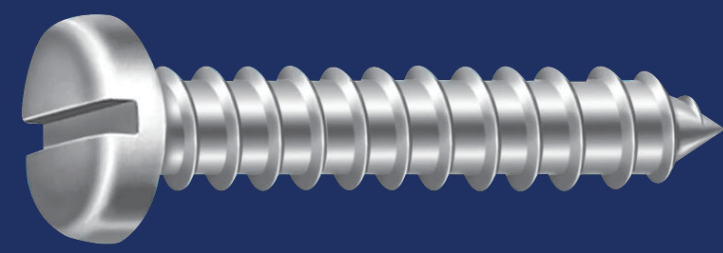

CABEÇA PANELA / Cabeza fijadora / Pan head



FENDA SIMPLES
Ranura sencillo / Slotted style

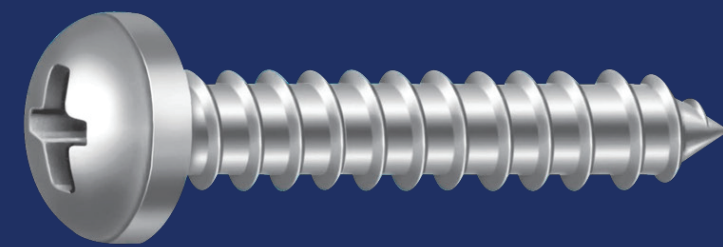

FENDA PHILLIPS
Ranura Phillips / Phillips style

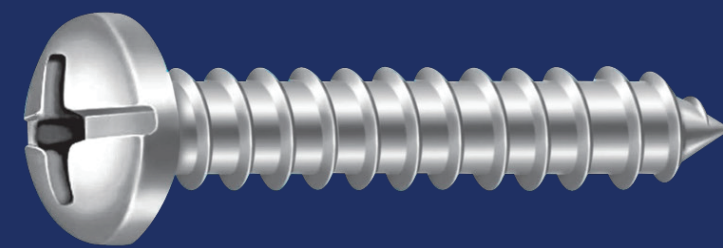

FENDA COMBINADA
Ranura combinada
Phillips & slotted style

TAMANHO NATURAL - ESCALA 1:1 / Tamaño normal / Regular size

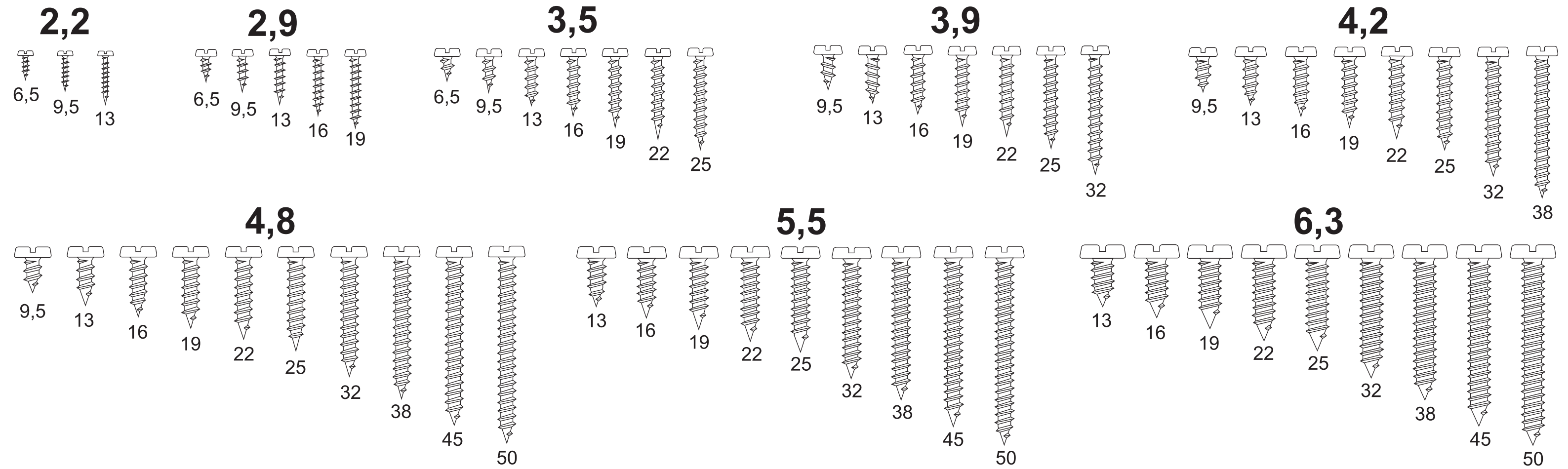

CABEÇA CHATA / Cabeza plana / Flat head

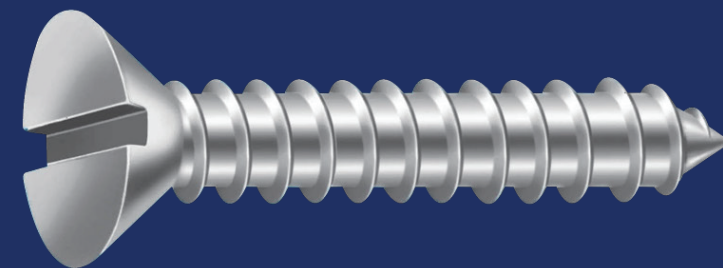

FENDA SIMPLES
Ranura sencillo / Slotted style

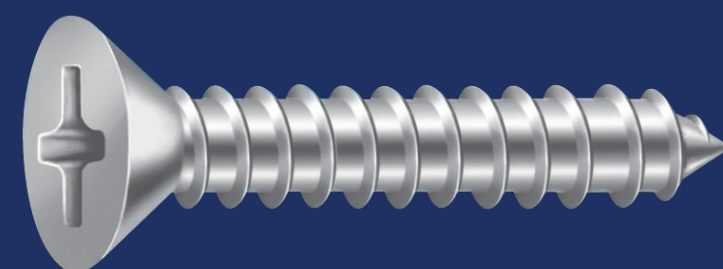

FENDA PHILLIPS
Ranura Phillips / Phillips style

CABEÇA OVAL / Cabeza ovalada (Gota de sebo) / Oval head

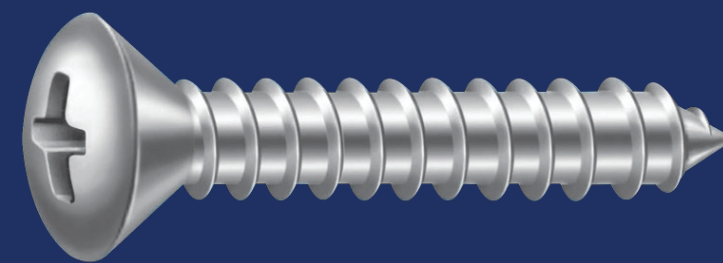

FENDA COMBINADA
Ranura combinada
Phillips & slotted style

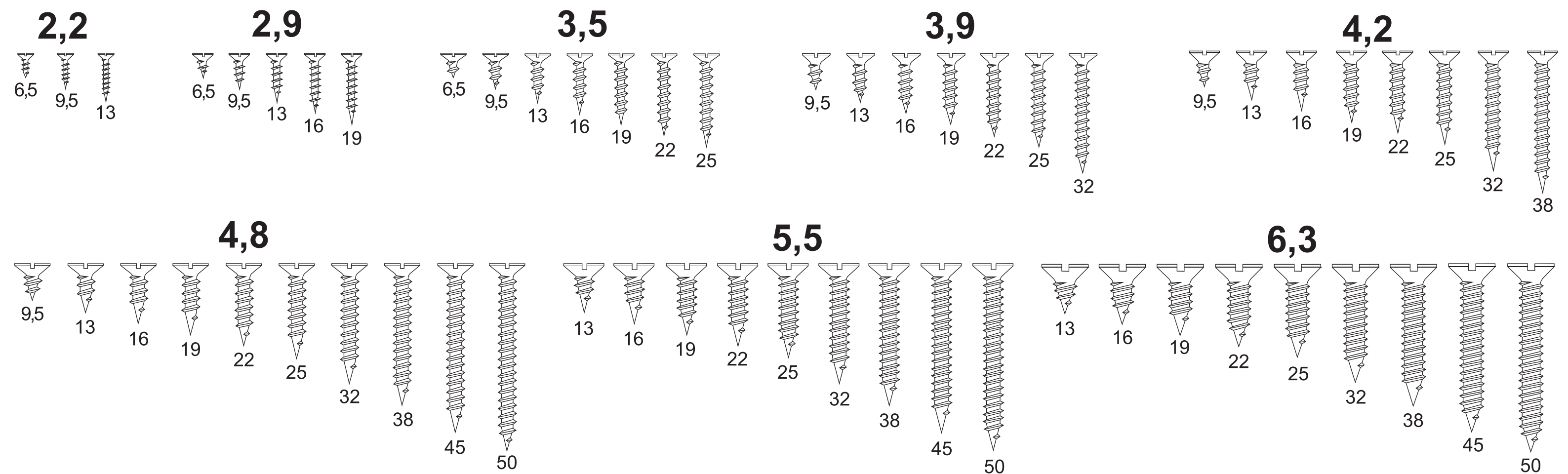

BITOLA mm Bitola/Size	mm	2,2	2,9	3,5	3,9	4,2	4,8	5,5	6,3
	N°	2	4	6	7	8	10	12	1/4"
ØD máx.		2,24	2,90	3,53	3,91	4,22	4,80	5,46	6,25
ØA máx.		4,2	5,6	6,9	7,5	8,2	9,5	10,8	12,5
Ha máx.		1,35	1,75	2,10	2,25	2,45	2,80	3,20	3,65
ØB máx.		4,3	5,5	6,8	7,5	8,1	9,5	10,8	12,4
Hb Ref.		1,3	1,7	2,1	2,3	2,5	3,0	3,4	3,8
f		0,7	0,9	1,2	1,3	1,4	1,5	1,7	2,0

PARAFUSOS X BUCHAS DE NYLON Tornillos x Taco de nylon/Screw x Nylon anchor ribbed type	
BUCHAS N° Taco Nr./Screw Anchor Nr.	BITOLAS APLICÁVEIS Medidas aplicables/Screw size
4	2,2
5	2,9 a 3,5
6	3,5 a 4,8
7	4,2 a 5,5
8	4,8 a 5,5
10	6,3

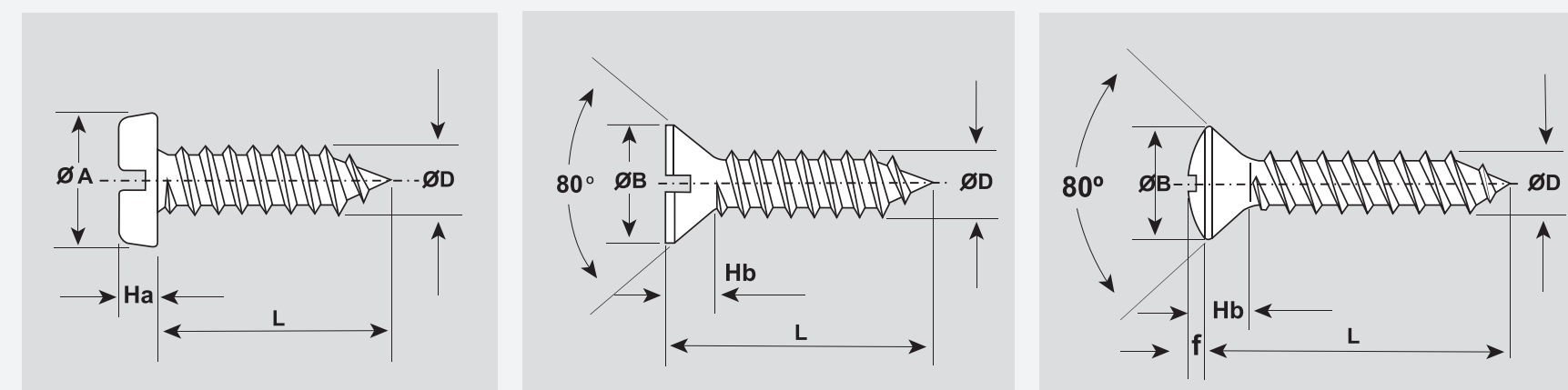

www.ciser.com.br